



HERCULUX
恒坤光电

Chengdu HercuLux Photoelectric
Technology Co.,Ltd
Product Approval

Approval number: _____

Customer: _____

Product: HK Matrix 4-in-1 60X148 Degree Street Lamp Lens (T2) (PC)

Material Code: 1.02.23189_PC

PN: HK-JZ-50@10-60X148-5050-#0-1g-4_PC

Manufacturer: Chengdu HercuLux Photoelectric Technology Co.,Ltd



| Supplier confirmation | | | | Client confirmation | | | |
|-----------------------|--|------|--|--------------------------------------|--|------|--|
| Proposed | | DATE | | Qualified <input type="checkbox"/> | | DATE | |
| Project manager | | DATE | | Unqualified <input type="checkbox"/> | | DATE | |
| Audit | | DATE | | Audit | | DATE | |
| Approved | | DATE | | Approved | | DATE | |
| Stamp | | DATE | | Stamp | | DATE | |

(Confirmation of acceptance by both parties must be signed and sealed)

Factory: Chengdu Shuangliu District, lot industrial park 2 road HercuLux Photoelectric Park

Phone: 028-85887727 (801) 028-85887990 (801)

Fax: 028-85887730

<http://www.herculux.com/>

Sales Dept: Shenzhen Nanshan District Nanshan Cloud Valley Innovation Industrial Park Comprehensive Service Building,

TEL: 0755-2937 1541

FAX: 0755-2907 5140

*Approval In duplicate, for both supplier and customer.

Please use this product within the permitted range and environment according to the structure and material of the product. If the usage exceeds the recommended value, please test and verify by yourself. If the product is damaged due to out-of-range use, our company will not be responsible for the warranty.

Product material:

Customized products: The specifications and models of materials used are subject to the agreement between the two parties.

Conventional products: As a product that we continuously research and improve, under the premise of ensuring the quality and availability of the product, our company reserves the right to change the material. If the material specification and model change, without prior notice.

product data:

The measurement data and dimensional tolerances of the 2D drawings in the product data sheet of this acknowledgement are for reference only, and the final size shall prevail in kind.

The measurement data presented in this acknowledgment is a performance test of the product based on our company's internal test conditions and quality requirements, and the reported data is a typical value of the average results of multiple measurements. Therefore, in some cases, the actual product may deviate from the data provided. We reserve the right to notify you in advance of this data.

Product changes and improvements:

Changes and improvements of customized products are subject to the agreement between the two parties in the contract or technical documents.

As the conventional products that we continue to research and improve, our company reserves the right to make technical changes to its products, and reserves the right to make changes to data resulting from improvements without prior notice.

Operation cautions:

1. Please wear clean gloves during product assembly to prevent product surface contamination.
2. Try to avoid touching the optical surface of the lens when taking the lens.
3. When the surface of the product is polluted, please wipe it gently with a soft cotton cloth dipped in analytically pure neutral solvent. It is forbidden to use industrial solvents (alcohol, isopropanol, acetone, ether, toluene, xylene, carbon tetrachloride, MMA monomer, etc.) wipe.
4. The lens made of PC should not be exposed to direct sunlight in the storage and use environment. If the lens turns yellow or cracks due to long-term sunlight exposure, our company will not be responsible for the warranty.



HERCULUX
恒坤光电

Basic product information

TEL: 0755-2937 1541

FAX: 0755-2907 5140

<http://www.herculux.com/>

Date updated: 2023/6/14

Product Picture:



Size(L*W*H/Φ*H):

L:50mm*W:50mm*H:7.6mm

Material:

PC

Efficiency:

\

Temperature(Topr):

Material extreme temperature resistance: -40°C to +120°C
long-term use temperature: -40°C to +100°C

FWHM:

60°X148°

Matched LES:

LUXEON 5050

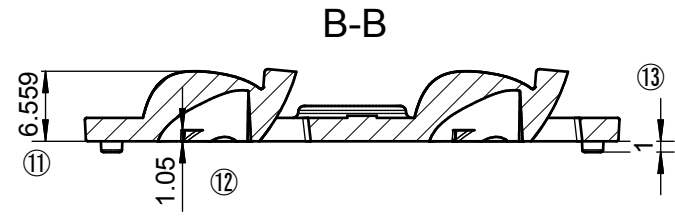
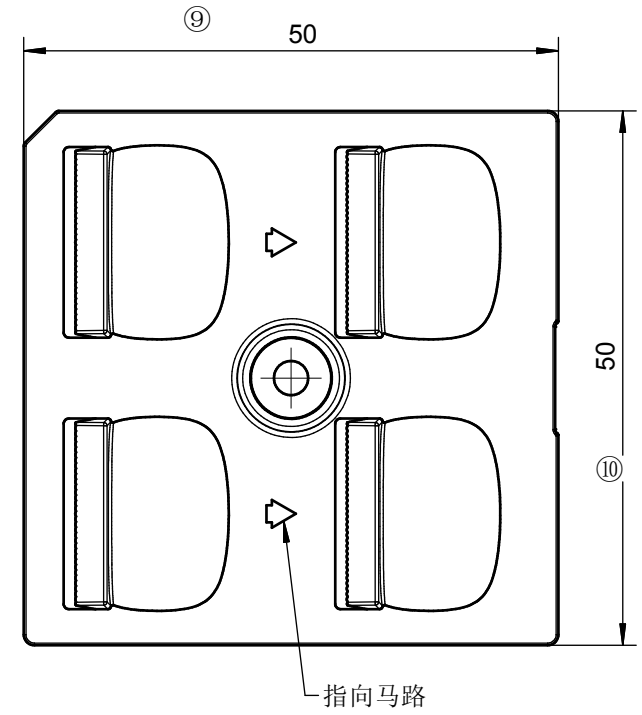
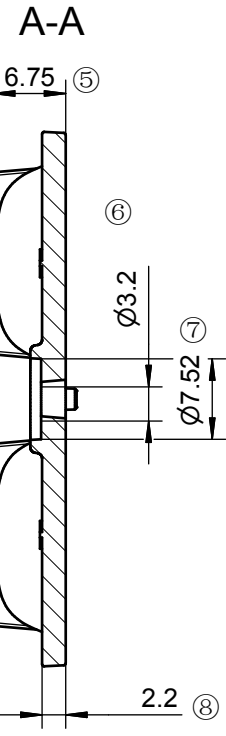
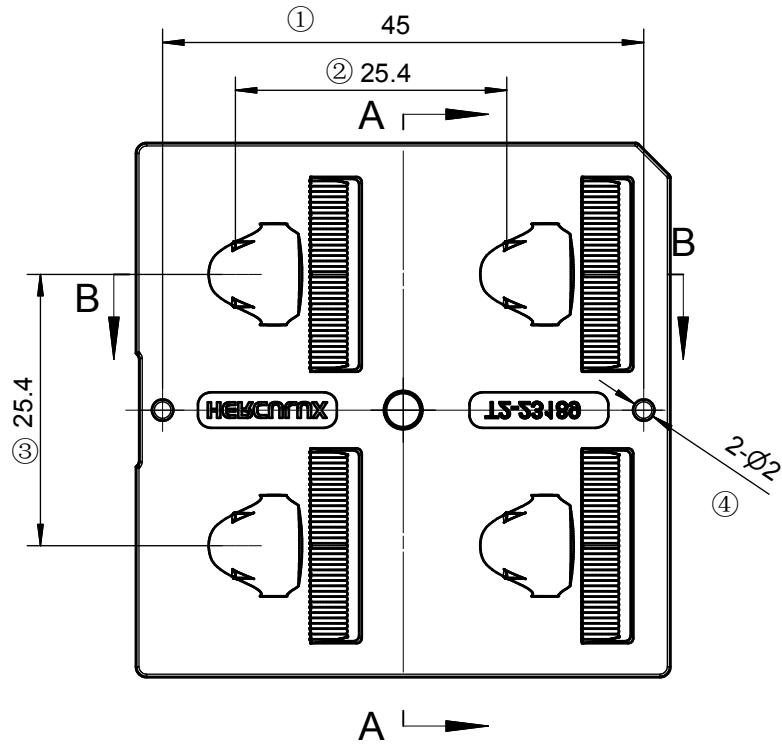

技术要求:
 1、未注圆角及拔模斜度按3D图。
 2、未注尺寸公差按右表。
 3、表面无飞边, 缩水, 气泡等缺陷。
 *4、灯具采用胶圈防水时: 要求散热器与胶圈的接触面的粗糙度: Ra<3.2μm

Technical remark:
 1.Fillet and inclination not indicated according to 3D drawing.
 2. Dimensional tolerances not indicated are shown in the right list.
 3. The surface has no flash, shrinkage, bubbles and other defects.
 *4. When the lamp adopts rubber ring for waterproofing: the roughness of the contact surface between the radiator and the rubber ring is required: Ra<3.2μm

| 基本尺寸 | 公差值 |
|------------|-----------------|
| Basic size | Tolerance value |
| <3 | ±0.1 |
| 3~10 | ±0.15 |
| 10~24 | ±0.20 |
| 24~65 | ±0.35 |
| 65~140 | ±0.50 |
| 140~250 | ±0.80 |
| 250~450 | ±1.2 |
| >450 | ±2.0 |

| | | | |
|----------------------------|-----|----------------------|--|
| 出光角度范围 Beam angle range | | 透过率 Transmittance | |
| 最小K值 Min K value | | 点胶类型 Gel type | |
| 模具等级 Mold level | 见图面 | 备注 Remark | |

| | | | | | | | | | | |
|---------------------------|---------------------|------------------------|---------------------|-----------------|--|---------------------|------------------------|---------------------|---|--|
| 2 | | | | | 4 | | | | | |
| 1 | | | | | 3 | | | | | |
| 序号 Item | 更改标记 Change mark | 更改内容 Change content | 更改日期 Change date | 签名 Signature | 序号 Item | 更改标记 Change mark | 更改内容 Change content | 更改日期 Change date | 签名 Signature | |
| 光学设计 Optical design | | | | | Title: HK-矩阵4合1 60X148度 路灯透镜 (T2) (PC) | | | | Drawing No. HK-JZ-50@10-60X148-5050-#0-1g-4_PC | |
| 结构设计 Structural design | | | | | | | | | Part No. 1.02.23189_PC | |
| 审核 Verify | | | | | 材料 Material: | PC | CDHK | | | |
| 审定 Approval | | | | | | | | | | |

Road Luminaire Photometric Data

Description Information

| | | |
|---------------------------------------|---------------------------------|-----------------------|
| Luminary Name: | Lum. Catalog: | Test ID: |
| Lamp Name: | Lamp Catalog: | Test Date: 2023/06/14 |
| Manufacture: | Shld. Ang(°): | Test Machine:GON-2000 |
| Test Lab: | Frequency(Hz): | Lamp CCT(K): Ra: |
| Lum. Size(W*L*H):0.000m*0.000m*0.000m | Lum. Area(m2):0.000 | Lum. W(kg): 0.000 |
| Test System: C, γ | Test Step: C=15.0 γ =1.0 | Temp.(°C): 25 |
| | | Humidity(%): 50.0 |

Character Parameter

| Lamp Speciality Parameter | | Luminaire Speciality Parameter | |
|--|---|---|--|
| Rated Flux(lm): 1000.000 | Luminary Flux(lm): 14370.855 | Down Lumens&Percent: 14207.030lm 98.86% | |
| Rated Power(W): | Luminary Efficiency: 1437.09% | Up Lumens&Percent: 163.825lm 1.14% | |
| Rated Voltage(V): | Luminary EER(lm/W): 121.581 | 76° Flash Area(m2): | |
| Tested Power(W): 118.200 | Max. Candela(cd): 8030.087 | SLI: 0.000 | |
| Lamps' Inside: 1 | Max Cand@Ang.(°): C=75.0 γ =60.0 | IES Classification: Type III | |
| Tested Electrics(V, A, pf):225.9, 0.530, 1.000 | Half Peak Angle(°): L=19.7, R=69.9 | Longitudinal Classfct: Very Short | |
| Lamp Size(W*L*H):0.000m*0.000m*0.000m | Field Angle(10%Imax): 151.2(°) | Cutoff Classification: Cutoff | |

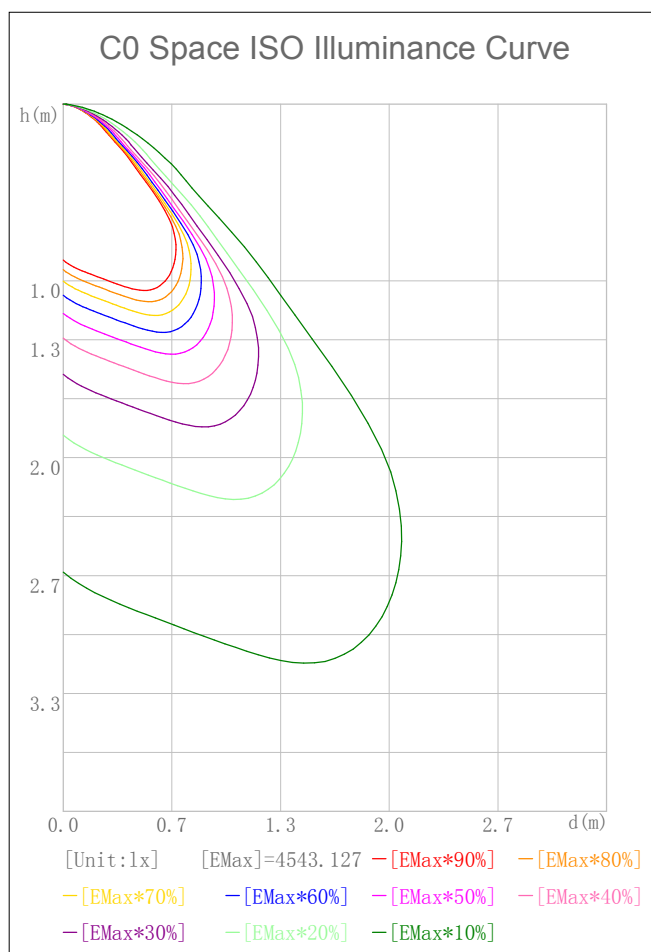
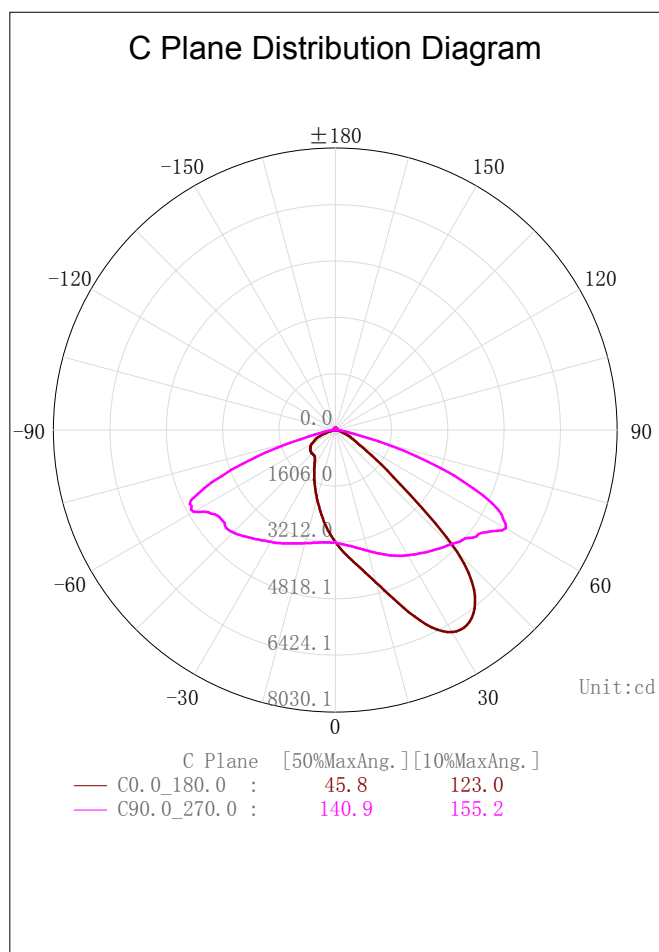

2D Plane Light Intensity Distribution Curve

| | | |
|--------------|-----------------------|-----------------------|
| Lum. Name: | Lum. Catalog: | Test ID: |
| Lamp Name: | Lamp Catalog: | Test Lab: |
| Manufacture: | Test Machine:GON-2000 | Test Date: 2023/06/14 |

C Plane Distribution Diagram

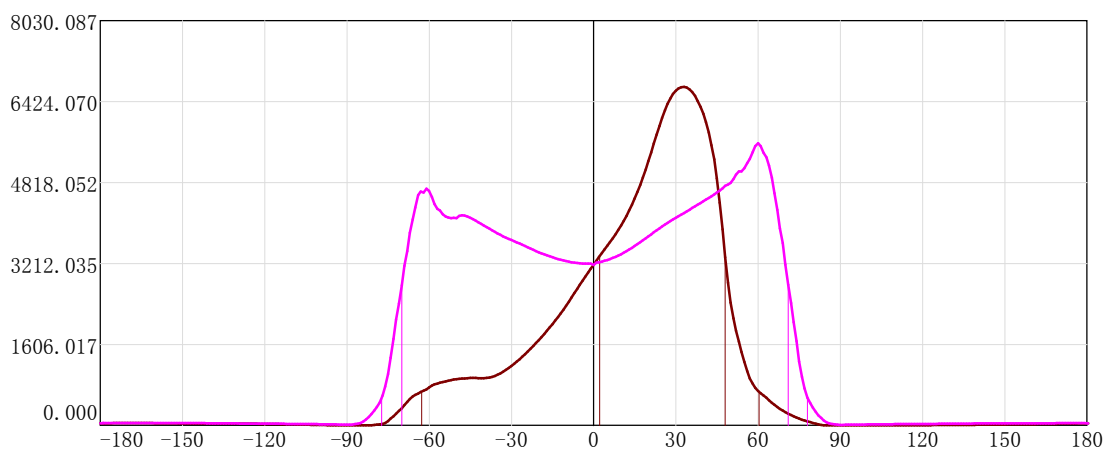
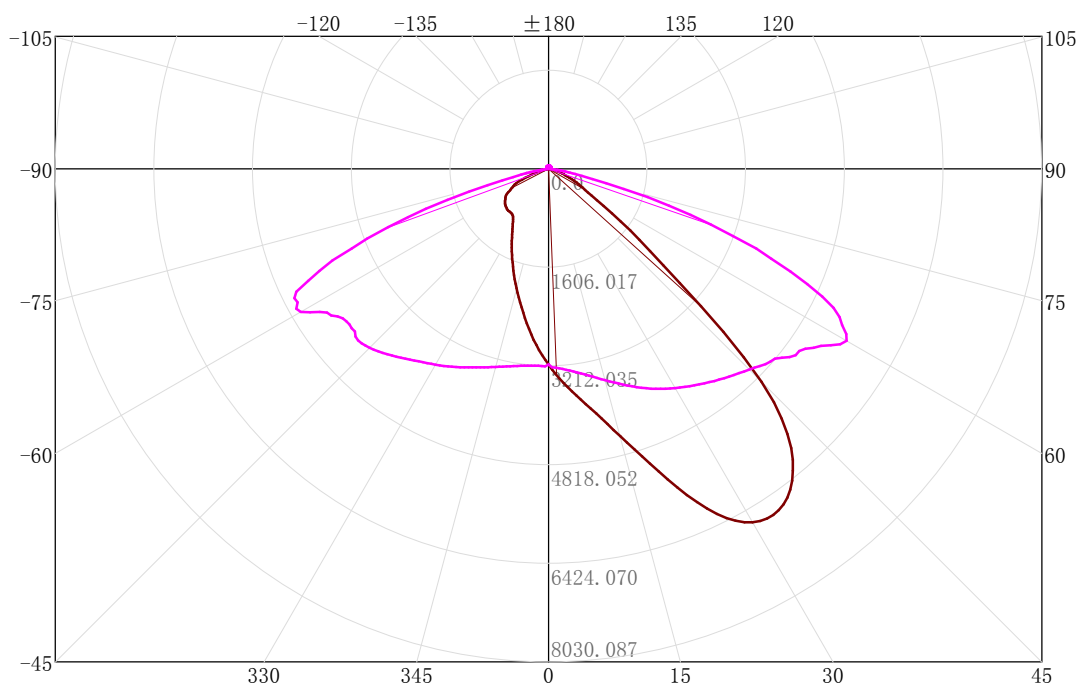

| | | | | |
|---|---------------|--------------|--------------|---------|
| — | C Plane | [50%MaxAng.] | [10%MaxAng.] | Unit:cd |
| — | C0.0_180.0 : | 45.8 | 123.0 | |
| — | C90.0_270.0 : | 140.9 | 155.2 | |

| | | Standard size | Upper Size limit | Lower size limit | Test resu lt1 | Test resu lt2 | Test resu lt3 | Test resu lt4 | Test resu lt5 | Test resu lt6 | Test resu lt7 | Test resu lt8 | Jud gme nt | Remarks |
|--|---|------------------------------|------------------|------------------|---------------|---------------|---------------|---------------|---------------|---------------|---------------|---------------|------------|--|
| 1.Size | OW | 50 | | | 50 | 50 | 50 | 50 | 50 | 50 | 50 | 50 | | Test environment: In 20 °C -25 °C environment to achieve thermal equilibrium after the test. |
| | S of locating | 45 | | | 45 | 45 | 45 | 45 | 45 | 45 | 45 | 45 | | |
| | D of locating | 2 | | | 2 | 2.1 | 2 | 2 | 2.1 | 2 | 2.1 | 2.1 | | |
| | TH | 2.2 | | | 2.2 | 2.3 | 2.2 | 2.2 | 2.3 | 2.3 | 2.2 | 2.2 | | |
| | Gate shear can not affect the appearance of the lamp | | | | | | | | | | | | | |
| See attachment "Appearance Inspection Standards" | | | | | | | | | | | | | | |
| 2.Appearance Quality | See attachment "Appearance Inspection Standards" | E | No burr | | No burr | | No burr | | No burr | | No burr | | OK | |
| | | | No stains | | No stains | | No stains | | No stains | | | | | |
| 3.Material | PC | | | | Color | | Transparent | | | | OK | | | |
| 4.Optical index | Testing LED | LUXEON 5050 | | | | | | | | | | | | |
| | The size and rated power of the light-emitting surface (LES) of the COB recommended by this lens should conform to the parameters in the product basic information table. if it is required to be out of range. According to the heat dissipation capability of the lamp and the actual conditions of the use environment, the lens should be fully tested and tested to prevent the lens life. | | | | | | | | | | | | | |
| | FWHM | See light distribution curve | | | | | | | | | | | | |
| | angle | | | | | | | | | | | | | |
| | Efficiency | | | | | | | | | | | | | |
| Facula | See the signature sample | | | | | | | | | | | | | |
| Comprehensive judgment | Qualified | | | | | | | | | | | | | |

Remarks:

- 1、 Tool Number: V-Vernier Caliper 2D-Quadratic H-Height Gauge M-Tool Microscope P-Needle T-Thick Gauge R-Radius Gauge E-Visual.
- 2、 Ambient temperature on the size of the product refer to the table on the right

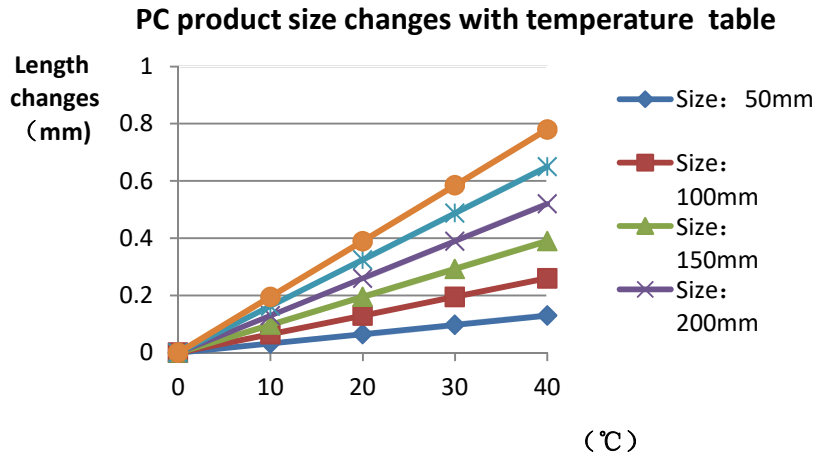

Precautions:

1. Please wear clean gloves during the lens assembly process to prevent the lens surface from being contaminated.
2. Try to avoid touching the total reflection surface when taking the lens.
3. The lens surface is contaminated. Only use a soft cotton cloth dipped in analytically pure neutral solvent to wipe gently. Do not wipe with industrial solvents (alcohol, isopropanol, acetone, ether, toluene, xylene, carbon tetrachloride, MMA Body, etc.).
4. The working temperature of the lens should be within the temperature resistance limit of the lens material. Exceeding the temperature resistance limit will cause the lens to crack or melt and affect the service life of the lens. It is recommended that the upper surface temperature of the LED colloid should be less than 120 degrees.

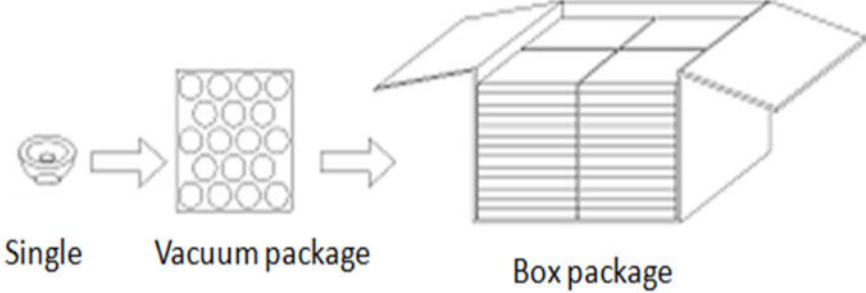
| | | | | | | | |
|---------------------|--|--|------------------|---|-----------|------|---------|
| PN | | HK-JZ-50@10-60X148-5050-#0-1g-4_PC | Product Name | HK Matrix 4-in-1 60X148 Degree Street Lamp Lens (T2) (PC) | | | |
| Product material | | PC | | | | | |
| Package diagram | |  <p style="text-align: center;"> Single Vacuum package Box package </p> | | | | | |
| Product packing | | 24 | A/ Box | 4 | PCS/Layer | | |
| | | 14 | Layer/Box | 1344 | A/ Carton | | |
| Packaging Materials | NO. | Part No | Part name | Size | Dosage | Unit | Remarks |
| | 1 | 2.07.0049 | Blister box | 23cm*21cm | 56 | BAG | |
| | 2 | 2.08.0001 | PE film | 30cm*30cm | 56 | PCS | |
| | 3 | 2.06.0005 | Reel label paper | 6.2cm*8cm | 56 | PCS | |
| | 4 | 2.06.0005 | Box label paper | 6.2cm*9.2cm | 1 | PCS | |
| | 5 | 2.06.0003 | big plate | 46.8cm*42.8cm | 15 | PCS | |
| | 6 | 2.06.0001 | big carton | 46.8cm*42.8cm*36cm | 1 | PCS | |
| Remarks | The loose packing is not subject to this specification. Customer's requirements shall prevail(There are three layers of 24 bags for each layer and 5 bags for the top layer) | | | | | | |

Special notice

When glue pass through holes, columns and other structures, or part of the thin structure, will form a weld line. The product which uses multi-point injection welding line will appear because of the combination of sol, as shown below:

Syntner

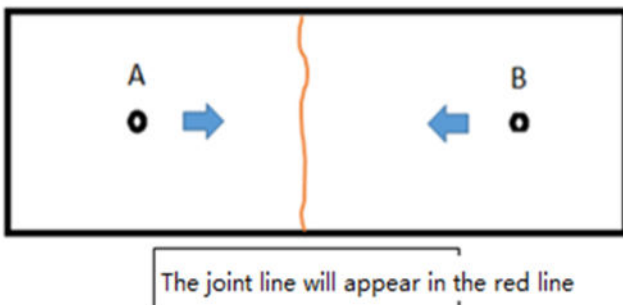
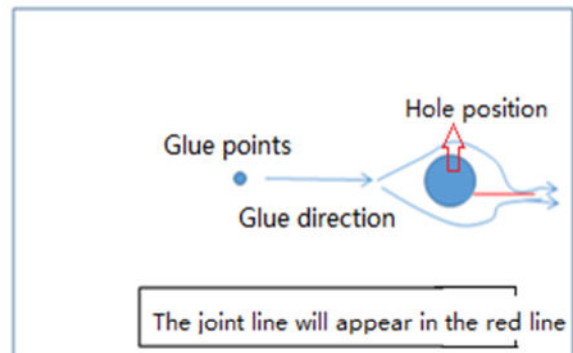
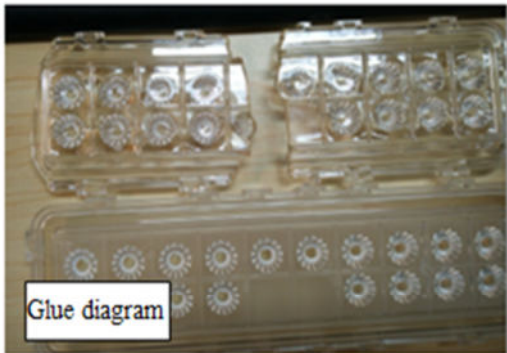
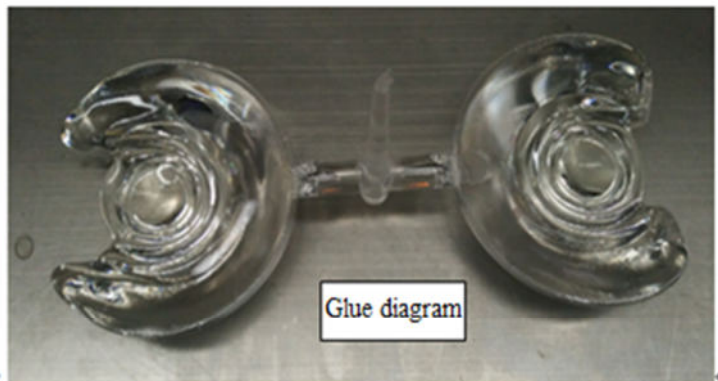

Please note :

The appearance of lines in the structure of the product as well as at the screw hole is a normal phenomenon, will not affect the actual use of the product, and can not be avoided at this stage.

Appearance inspection standards

1 Operating procedures

1.1.1 Sampling standards, sampling plan and AQL

Test level: GB/T2828.1-2012 The first part is according to the acceptance quality limit (AQL) retrieval batch inspection sampling plan, general inspection level II level, CR class defect coefficient 0, MA defect rejection level AQL = 0.65, MI class defect rejection level AQL = 1.0; defect level please see 5.4.

2 Code table

| Code | Code description | Unit | Code | | Code description | Unit |
|------|------------------|-----------------|------|--|------------------|------|
| N | Amount/pcs | pcs | D | | Diameter | mm |
| L | Length | mm | H | | Depth | mm |
| W | Width | mm | DS | | Distance | mm |
| S | Proportion | mm ² | SS | | Offset | mm |

3 Test conditions

3.1 Sight distance and working hours: Sight distance should be 30-35cm, each side of the inspection time does not exceed 12s, the visual angle of 45-135 degrees;

3.2 Light: 2x40w cool white fluorescent lamp, the light source is 500-550mm away from the lens surface; in order to make the appearance defect can be correctly recognized, the illumination should be 500-1000Lux, and the observation time is 10 seconds.

3.3 Visual inspection staff should be 1.0 (including corrected visual acuity) above, no color blindness, color weakness.

4 Appearance inspection standards

| Test items | Judging standard | Inspection equipment | Defect level | | |
|------------------|--|-------------------------------|--------------|----|----|
| | | Testing method | MI | MA | CR |
| Check the sample | When start the machine and process, all products have to check the appearance of the sample, the appearance of the sample is divided into qualified samples and limited samples. | Sample comparison , visual | | | √ |
| | 1: Qualified sample refers to the appearance and structure standard of the product which recognized by the client, the sample size should be confirmed before mass production; | | | | |

| | | | | | |
|---|---|------------------------------|--|---|---|
| | 2: The limited sample refers to the limit of a particular exceptionally developed sample. Limit the sample only for its specific point of exception to confirm; The priority is higher than the other criteria in this table. When there is a limited sample, the limit sample shall prevail. | | | | |
| Raw edge | Not allowed to affect the size and assembly | Visual, point card | | √ | |
| Scratch | 1: Non-optical surface and non-exposed surface scratches should be visually insignificant and the length is less than 1/10 of the maximum surface size. | Visual, point card, calipers | | √ | |
| Fingerprint | Fingerprints are not allowed on all products | Visual | | √ | |
| Foreign objects, black spots, white spots | The product may not be attached to foreign objects, including oil, fiber, dregs of water gap and so on | | | | √ |
| Deformation | Insufficient filling shall not affect the appearance of the assembly and the exposed surfaces. | Visual, feeler | | | √ |
| Poor ejection | Products may not appear bad ejection, including no convex top, thimble printed on the assembly surface shall not be higher than the product surface, non-assembled surface thimble height should not exceed the product size tolerances; thimble printing should be less than the product surface and no more than 0.3; thimble surface treatment should be consistent with the product side. | Visual, point card | | √ | |
| | Ejection strain: the optical surface and the appearance of the exposed surface after assembly are not allowed to have a strain, and the structural surface does not allow visual obvious strain. | | | | |
| Insufficient filling | Insufficient filling shall not affect the appearance of the assembly and the exposed surfaces, The signature sample shall prevail. | Visual, point card | | √ | |
| Shrink | When the entire surface of the product shrinks, the optical properties and dimensions must meet the requirements, and the visual will not significantly affect the appearance. Part shrink reference point defects | Visual, point card | | √ | |
| Flow marks, Welding line | 1: Product does not allow the presence of flow marks and welding lines unless the structure can not be avoided; | Visual | | √ | |
| | 2: The remaining flow marks shall not appear in the optical surface, a single $L \leq 10\text{mm}$, no more than two | | | | |

| | | | | | |
|---|--|--------------------|---|---|---|
| Bubble | No bubbles are allowed | Visual | | √ | |
| Foreign objects, black spots, white spots | Not obvious or $D \leq 0.3\text{mm}$ black spots and foreign bodies in the area of 100x100mm not more than 1; Exceeded foreign matter black spots is judged bad. | Visual, point card | √ | | |
| Damaged | No damage is allowed | Visual | | | √ |
| Cold glue | Optical surface may not have cold glue, non-optical surface cold glue should meet the visual is not obvious. | Visual | √ | | |
| Bad incision | 1: Do not affect the product size, shall not penetrate the optical surface, the cut should be smooth; | Visual | | | √ |
| | 2: Laser cutting products, the optical surface burns shall not occur after the processing is completed. Beading must not affect product installation | | | | |
| | 3: Three molds and hot runner gate shall not appear residue. | | | | |
| Scrub | Scrub surface should be uniform, off the scrub phenomenon should not be obvious , A single off scrub imprint requires $D \leq 1\text{ mm}$ and no more than 1 area within a 50x50 mm area | Visual | | √ | |